

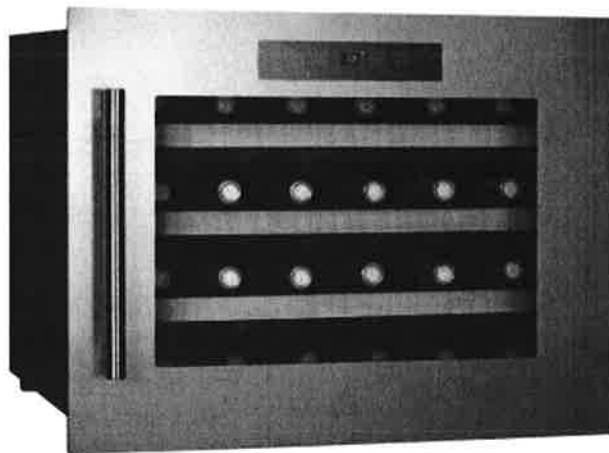

SINGLE ZONE CELLAR

WC24SS



INSTRUCTION MANUAL

*This manual contains important information including **safety and installation instructions** of the appliances. Please read it carefully before use and follow all safety information & instructions.*

It is recommended to keep this manual for easy reference so that you can be familiar with the operation of the appliance

--CONTENTS--

IMPORTANT SAFETY INFORMATION	14
STRUCTURE AND INSTALLATION.....	15
ACCESSORY INSTALLATION BEFORE OPERATING	16
UNPACKING AND CLEANING THE WINE COOLER.....	16
OPERATING THE WINE COOLER.....	16
WORKING CLIMATE.....	16
WINE STORAGE	17
CONTROL PANEL	17
POWER ON/OFF CONTROL	18
UNLOCKING THE CONTROL PANEL.....	18
INTERIOR LIGHTING ON/OFF CONTROL.....	18
TEMPERATURE DISPLAY WINDOW	18
TEMPERATURE SETTING.....	18
SELECTING FAHRENHEIT (°F) & CELSIUS (°C) DISPLAY	19
CARE AND MAINTENANCE	19
CLEANING THE WINE COOLER.....	19
POWER FAILURE.....	19
MOVING THE WINE COOLER.....	19
ENERGY SAVING TIPS	19
TROUBLESHOOTING.....	20
WARRANTY REGISTRATION CARD.....	22

IMPORTANT SAFETY INFORMATION

Before using the appliance, please properly position and install it as described in this manual. To avoid the risk of fire, electrical shock, or injury when using the appliance, follow these basic precautions:

- The appliance is intended to be used exclusively for the storage of wine.
- Make sure the voltage/current marked on the rating label corresponds with your supply voltage. Plug into a grounded 3-pin outlet, do not remove grounding pin, do not use an adapter, and do not use an extension cord.
- It is recommended that a separate circuit, serving only your appliance be provided.
- Never clean the appliance parts with flammable fluids which may create a fire hazard or explosion. And do not store or use gasoline or other flammable vapors and liquids in the vicinity of the appliance.
- Do not connect or disconnect the electric plug when your hands are wet.
- Unplug the appliance or disconnect power before cleaning, maintenance or servicing. Failure to do so can result in electrical shock or death.
- Do not attempt to repair or replace any part of the appliance unless it is specifically recommended in this manual. All other servicing should be referred to a qualified technician.
- Ensure enough peoples to move and install the appliance to avoid any damage to the appliance or injury to the peoples.
- To ensure proper ventilation for the appliance, the front of the unit must be completely unobstructed. Locate the unit away from direct sunlight and sources of heat (stove, heater, radiator, etc.).
- The fuse (or circuit breaker) size should be 15 amps or higher.
- It is important for the appliance to be leveled in order to work properly. You may adjust the appliance's feet to level it.
- This appliance intended for use by persons with sufficient experience and knowledge of electrical appliances. Any other persons (including children) should be supervised or given instruction concerning use of the appliance by a person responsible for their safety.
- Children should be supervised to ensure that they do not play with the appliance.
- Do not use solvent-based cleaning agents or abrasives on the interior. These cleaners may damage or discolor the interior.
- Do not use this appliance for other than its intended purpose.
- The use of attachments not recommended by the manufacturer may be hazardous.
- When you dispose the appliance, take off the door and leave the shelves in place so that children may not easily climb inside. And make sure the coolant circuit; particularly the heat exchanger at the back/bottom of the unit is not be damaged. The  symbol on the product or its packaging indicates that this product is not to be handled as normal household waste and it is to be taken to a recycling collection point for electrical and electronic goods.

STRUCTURE AND INSTALLATION

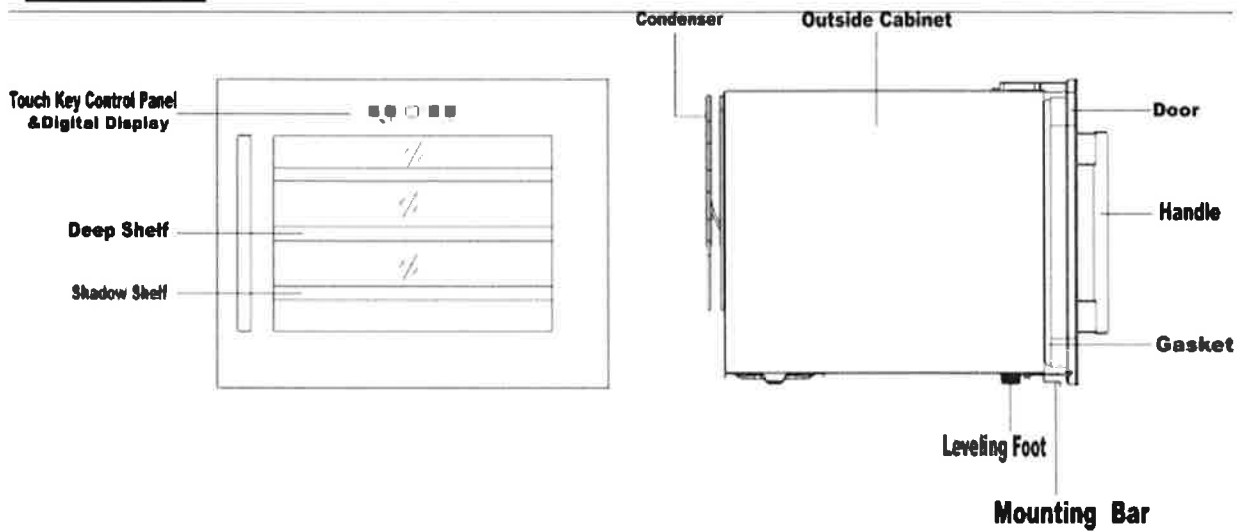

The following pictures only show the structure of the appliance. The dimension and shelf quantity may differ among the models of the same series.

STRUCTURE

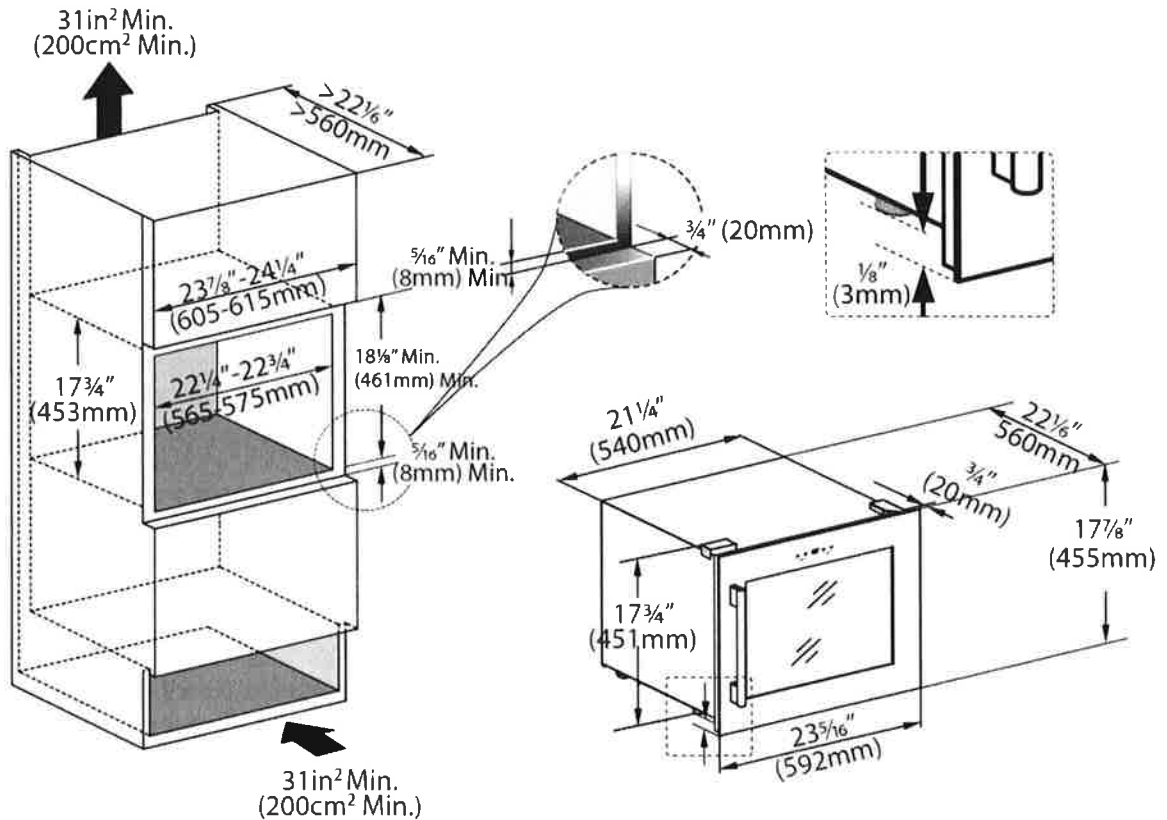

INSTALLATION DRAWING



1. Before inserting the unit into the kitchen cabinet, please unscrew the original 4 leveling feet  (**in white**), and screw the 2 short leveling feet  (**in black**), which are packed as the accessory, to the front bottom of the unit.
2. Tighten the 2 screws to fix the **Bottom Mounting Bar** (which has been fixed on the bottom of the unit) to the kitchen cabinet.
3. For a firmly fixing of the unit, you can install an extra **Top Mounting Bar** (which is an accessory packed with the unit) onto the topside of the unit, and screw it with the kitchen cabinet. See right

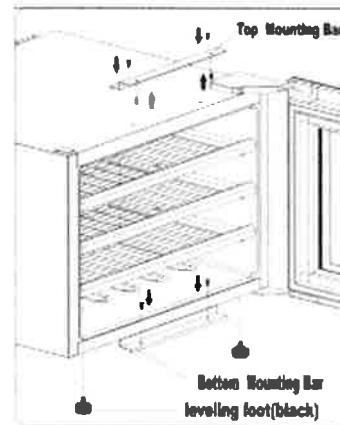

ACCESSORY INSTALLATION BEFORE OPERATING

UNPACKING AND CLEANING THE WINE COOLER

- Remove the exterior and interior packing materials.
- Let the appliance stand upright for approximately **24 hours** before connecting it to the power source, which helps to reduce the possibility of a cooling-system malfunction from handling during transportation.
- Use a soft cloth to clean the interior surface with warm water.
- Install the door handle provided with the appliance by following these steps:

1st Step - Remove the gasket on the internal door to expose the two screw holes.

2nd Step - Install the handle with the screws and washers provided.

3rd Step - Restore the gasket.

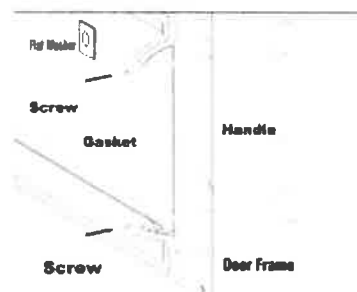

OPERATING THE WINE COOLER

WORKING CLIMATE

- The appliance is designed for operating from SN to N climate (see below climate class chart). It is recommended to maintain the ambient around 22-25°C (71-77°F) which helps the appliance working with low power consumption.

Climate Class	Ambient Temperature
SN	10 - 32 °C (50-90°F)
N	16 - 32 °C (61-90°F)
ST	18-38 °C (64-100°F)
T	18-43 °C (64-109°F)

- If the ambient temperature is above or below the designed climate range, the performance of the unit may be affected. For example, the appliance operating in extreme cold or hot conditions may cause interior temperatures to fluctuate, and the temperature set 5-22°C may not be reached sometimes.

WINE STORAGE

- The standard shelves are designed perfectly for Bordeaux bottle storage. The maximum loaded bottles may vary subject to the different size or dimension wine bottles you store.
- The shelves are with telescopic rails which allows pulling out by 30% for easy access to the wine storage.

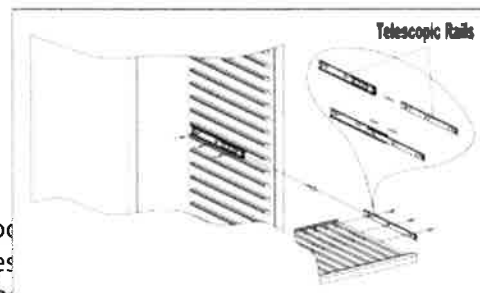

- To prevent damaging the door, open the door fully all the way before pulling the shelves out.
- Please store wine in sealed bottles.
- Do not cover the shelves with aluminum foil or any other shelf material which may prevent air circulation.
- Should the wine cooler be left empty for long periods it is suggested that the appliance is unplugged, and after careful cleaning, leave the door ajar to allow air to circulate inside the cabinet in order to avoid possible condensation, mold or odors forming.



Recommended temperatures for chilling/storing your wines.

Wine Type	Recommender Temp.
Red Wines	15 - 18°C (59-64°F)
Dry/White Wines	9 - 14°C (48-57°F)
Rose Wines	10 - 11°C (50-52°F)
Sparkling Wines	5 - 8°C (41-46°F)

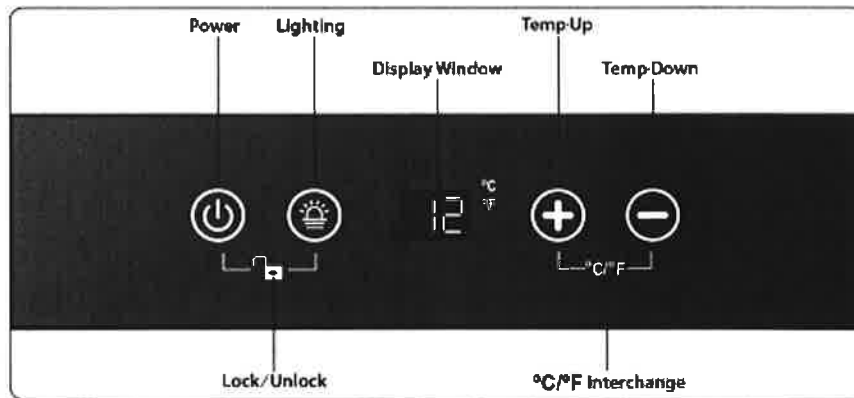
CONTROL PANEL





POWER ON/OFF

- When the appli:
- Touch the power mark  and hold for **10 seconds** to turn off (or turn on) the appliance.
- No matter it is under a locked or unlocked situation, you can turn off the appliance by touching the power mark  and holding for **10 seconds**.

Warning: To avoid breaking the compressor, please do not turn on the appliance again within **5 minutes** after you turn it off.



UNLOCKING THE CONTROL PANEL

- To unlock the control panel, touch the power mark and lighting mark   with 2 fingers at the same time and hold for **3 seconds**. When unlocked a buzz sound will be heard.
- The control panel will be automatically locked with a buzz sound heard after **10 seconds** without being touched.
- Under the locked situation, the control panel will not react to any touching order for Lighting On/Off and Temperature Setting.

INTERIOR LIGHTING ON/OFF CONTROL

- Under the unlocked situation, touch the lighting mark  to turn on (or turn off) the interior cool LED lighting.
- The lighting will be continuously on if it is not turned off.







TEMPERATURE DISPLAY WINDOW

- The temperature is displayed in digital which is the best way to be read out. The digital is shown as the set temperature when you are setting the temperature, and it will change to be the real temperature of the inside cabinet after **10 seconds** without being touched.
- When the temperature probe is out of order, the display window will show with "HH" or "LL" instead of a digital figure while continuous buzz sound will be heard. In case of this happens, this appliance is considerably designed to keep periodical running of compressor and fans which helps to keep the coldness of the inside cabinet to protect your stored wines.

Warning: To avoid destroying your stored wines, it is strongly recommended to have the appliance repaired immediately, as the spare periodical running can not ensure the appliance to achieve the temperature you have set.





TEMPERATURE SETTING

- The temperature setting range is 5-22 °C (41-72 °F).
- Directly touch the  or  mark to set the wine cooler temperature as you want.
- The first touch on  or  mark will recall the previous set temperature displayed in the digital window.
- Touch the mark  to increase the set temperature by 1°C (or by 1°F). On the contrary, touch the mark  to decrease the set temperature by 1°C (or by 1°F).
- The digital will change to display the real temperature of the inside cabinet after 10 seconds without being touched.

Note: For the first time to use the appliance or to restart the appliance after having been shut off for a long time, you may find a few degrees variance between the set temperature and the displayed temperature. It is normal and everything of the appliance will be in the order after a few hours running.

SELECTING FAHRENHEIT(°F) & CELSIUS (°C) DISPLAY



Touch the marks   with 2 fingers at the same time and hold for 5 seconds, you can interchange the Fahrenheit and Celsius display.

CARE AND MAINTENANCE

CLEANING THE WINE COOLER

- Turn off the power, unplug the appliance, and remove all items including shelves.
- Wipe the inside surfaces with a sponge and baking soda solution. The solution should be about 2 tablespoons of baking soda to 1 quart (approx. 1 litre) of warm water.
- Wash the shelves with a mild detergent solution. Allow wooden shelves to dry before placing back into the wine cooler.
- Wring excess water out of the sponge or cloth when cleaning area of the controls, or any electrical parts.
- Wipe the outside cabinet with warm water and mild liquid detergent. Wipe dry with a clean soft cloth.
- Do not use steel wool or steel brush on the stainless steel. These will scratch the stainless steel with steel particles and rusting may occur.

POWER FAILURE

Most power failures are corrected within a few hours and should not affect the temperature of your appliance if you minimize the number of times of door opening. If the power is going to be off for a longer period of time, you need to take the proper steps to protect your contents.

MOVING THE WINE COOLER

- Remove all items.
- Securely tape down all loose items (shelves) inside your appliance.
- Turn the adjustable leg up to the base to avoid damage.
- Tape the door to shut.
- Be sure the appliance stays secure in the upright position during transportation. Also protect outside of appliance with a blanket, or similar item.

ENERGY SAVING TIPS

- The appliance should be located away from heat producing appliances, and away from direct sunlight.
- Ensure that the unit is adequately ventilated. Never cover air vents.
- Only open the door when necessary. Avoid leaving the door open for long periods or opening/closing the door frequently.

TROUBLE SHOOTING

If you feel the appliance is not working properly, follow these instructions to try to see if you can solve the problem simply by yourself before calling for service.

No.	PROBLEM	PROBLEM POSSIBLE CAUSE / MEASURE
1	The wine cooler does not operate	Not plugged in. The appliance is turned off. The circuit breaker tripped or a blown fuse. It is recommended to use an exclusive 15 amperes circuit breaker for your cellar.
2	The wine cooler is not cold enough	Check the temperature control setting. External environment may require a higher setting. The door is opened too frequently. The door is not closed completely. The door gasket does not seal properly.
3	Sometimes the temperature of my cellar varies from 3-4 degrees, is it normal?	It is normal, variation of temperature are required to operate the cellar. When the defrost cycle starts, the temperature increase of some degrees. When the refrigeration system starts, the temperature becomes cooler. These changes are performed on short periods of time. Their influences are too small to affect the preservation of your wines.
4	My cellar doesn't keep his temperature and the compressor starts often?	Does your cellar is at least 50% full? Your cellar is in operation for more than 48 hours?

No.	PROBLEM	PROBLEM POSSIBLE CAUSE / MEASURE
5	Automatically turn-on and turn-off frequently	The room temperature is hotter than normal. A large amount of contents has been added to the wine cooler. The door is opened too frequently. The door is not closed completely. The temperature control is not set correctly. The door gasket does not seal properly.
6	The lighting does not work	Not plugged in. The circuit breaker tripped or a blown fuse. The lighting is turned off.
7	Too much vibration	Check to assure that the appliance is level. Check to assure no parts inside the cabinet or in the compressor chamber are loose.
8	The wine cooler seems to make too much noise	The rattling noise may come from the flow of the refrigerant, which is normal. As each cycle ends, you may hear gurgling sounds caused by the flow of refrigerant. Contraction and expansion of the inside walls may cause popping and crackling noises. The appliance is not level.
9	The door will not close properly.	The wine cooler is not level. The door was reversed and not properly installed. The gasket is dirty. The shelves are out of position.
10	The door is not at level with the cabinet	Adjust the legs at the front of the cellar until the door is at level with the cabinet.
11	The door is opening by itself	It is probably because the guide is not equal to the « L » piece. Make sure the cellar is at level.
12	A shelf is not at level	Make sure the guide are well engage
13	After inserting the key the cellar still lock	The handle(lock) is not notch or the nut is not equal to the « L » piece. Make sure the door is at level with the cabinet
14	There is water on the cellar floor	Make sure the drain is in the evaporation tray in the back of the cellar. If so, during humid temperature, you might have to wipe off the excess in the tray with a sponge
15	Accumulation of water inside the cellar?	This phenomena might occurs in summer, reason of humidity. Verify if the door seal is hermetic. It is recommended during humid temperature to wipe off the excess of water inside the cellar.
16	Frost on the evaporator?	It is normal when the water vapor freeze. However when the cooling cycle is finish, the ice will become water.

No.	PROBLEM	PROBLEM POSSIBLE CAUSE / MEASURE
17	Steaming/humidity between the thermal windows	During summer with humid temperature, this situation might occur.
18	The display window is shown with "HH" or "LL" instead of a digital figure, and/or with continuous buzz sound.	The temperature probe is out of order.





WARRANTY REGISTRATION CARD

CARTE D'ENREGISTREMENT DE GARANTIE

First Name / Prénom	Last Name / Nom		
Address / Adresse	City / Ville	Prov.	Postal Code / Code Postal
Tel / Tél.	Email / Courriel		

Purchase Date / Date d'achat	Purchased From / Acheté par

	www.winecellr.ca
--	--